



Kalmar Heavy Forklifts DCG180-330

18 – 33 tonne capacity

A vital part of your logistics

No chain is stronger than its weakest link, as the saying goes. Nothing could be more true when it comes to managing heavy or bulky components between the key stages of the logistic value chain. On or off ships or trains. Between the foundry and the factory. From assembly to transportation.

This is the domain of the heavy forklift truck. No other piece of machinery matches a forklift's combination of raw strength, mobility and versatility. But it's a tough job.

The sheer weight of thousands of tonnes lifted each day wears the mechanics and the materials. Yet the forklift must perform flawlessly every day of the week. Reliably, productively, safely.

Your forklift is a vital part of your logistics or production. In seamless interaction with a skilled operator, the forklift must meet your – and your customer's – demands of product quality and delivery precision, throughout your terminal, factory or assembly line.

Looking at your forklifts in this light, the choice of brand will come naturally. Only the best is good enough. Kalmar is equally renowned for its robust and reliable product quality as for its global service network and supreme customer support.

Heavy forklift trucks are Kalmar territory since 1949 – making your material handling the strongest link in the logistic value chain.

4 good reasons to choose Kalmar



It is no surprise that customer survey results coincide with Kalmar core values. After all, we listen attentively to customers when designing and developing our forklifts. Looking at the big picture, adding up things that truly matter, it will always pay off to choose Kalmar.



Designed for maximum productivity



Your Kalmar forklift will always deliver what your operations require. With Performance mode activated, operators will have the power necessary to go all-in at every instant and work with maximum productivity. Pushing it hard, while ensuring best-in-class fine-manoeuving.

Our Cummins engines are powerful, yet highly fuel efficient. All engine alternatives are compliant with emission standard Stage IV/Tier 4 Final.

The variable pumps automatically sense the load in every operation and adjust

the oil flow accordingly, allowing for faster lifting cycles up to 40 per cent while reducing fuel consumption. **This will improve your productivity a lot depending on number of lift cycles.**

Many operators testify to the forklift's improved operational capabilities, especially when fine manoeuvring, such as side-shift and fork positioning. Also, the lowering speed has been increased, preparing the machine faster for the next lift.

Drive modes

Choose between three different drive modes, each optimised to meet your operational requirements. The forklift can be adapted to every task at hand, shifting many times during the day. The operator easily shifts between modes by using the cabin display screen.

Power

Brings out maximum performance of your machine, allowing you to increase the number of tonnes moved per hour.

Normal

Balances power and economy to optimise profitability.

Economy

If total cost of operations outweighs the need for performance, Economy mode reduces fuel consumption by up to 15 per cent.



* DCG180-250, lift/lowering speed compared to DCF180-250.

Reducing lifetime costs

Purchase price is only one of many factors affecting total cost of ownership. In fact, price is a minor cost factor looking over the lifetime of your forklift. What truly matters in the long run is cost control and operational efficiency – and that will show clearly on your bottom line.

Compared to our previous model, the new DCG180-330 uses up to 15 per cent less fuel* in standard configuration. Add Kalmar's renowned product quality and reliability, increasing efficiency and uptime, and you see the true value of Kalmar.

The forklift's variable pumps and fan are automatically adjusted to the precise need.

The pumps and the fan are only operated at full speed when necessary, reducing fuel consumption and noise. Another cost saving feature is Economy mode, an engine setting available to the operator from within the cabin, which lowers fuel consumption even more.

Thanks to improved and more durable components, service intervals have been extended. The first service is due after 500 hours, compared to 50 hours for our previous model.

The risk of unplanned standstills has been reduced due to intelligent error detection built into the new control system, which accurately pinpoints potential problems in clear text on a display in the cabin.

Cost saving features

Fuel-efficient engine

The new Stage IV/Tier 4 Final compliant engines reduce fuel consumption by up to **5 per cent***.

Economy drive mode

Using Economy drive mode, fuel consumption is reduced by up to **15 per cent**.

Energy efficient systems

Optimized variable hydraulic system and variable cooling fan allows for savings up to **10 per cent**.

Increased uptime

Longer service intervals and improved problem detection reduce downtime.

Total lifetime savings

Adding all energy saving features, savings up to **30 per cent** are possible.



Lifetime savings

Purchase price represents only a small part of the total cost of ownership. What matters in the long run is reducing operational and maintenance costs. And that is what Kalmar is all about.

* Compared to Kalmar DCF180-330 with Stage IIIB engine.



Prioritizing safety and operator ergonomics

Safety always comes first. Kalmar makes every effort to guarantee that our machines are safe to operate at every worksite around the world. We spend extensive R&D resources to ensure the driver's environment in the cabin is optimal regarding ergonomics, visibility and noise.

First introduced in 2011, our Ego cabin offers the ultimate in ergonomics and safety. Numerous electronically operated adjustments allow the operator to tailor his workplace. The curved windows, which greatly improve visibility, have already become a classic with Kalmar.

The wheel is tiltable sideways, allowing the operator to temporarily change his visual angle, to see around bulky load in front of him. A new 300 mm lower carriage, available with the DCG180-250 versions, further improves visibility in the forward direction.

The operator console is the operator's extended arm, easy to understand, use and adjust. Designed for maximum ergonomics and flexibility, the console puts controls, switches and indicators within easy reach to the operator, ensuring the most efficient forklift operation possible.



Keeping you operational at all times

Kalmar offers extensive service and support packages, available to you wherever your operation may be located. As part of a world-wide industrial group, Kalmar is better positioned than most other forklift manufacturers to provide a truly global service.

Besides forklifts, Kalmar offers reachstackers, terminal tractors, empty container handlers and other types of terminal equipment. Therefore, we have more people in the field ready to provide fast assistance, whenever you need it.

Supporting you also means simplifying the use of our products – in terms of serviceability, service accessibility and error prevention.

Our main concern is to keep you operational at all times, reducing the risk of unplanned downtime.

The DCG180–330 is the fourth machine to be released from Kalmar's G-generation. Service engineers are familiar with the concept, allowing them to reuse skills and knowledge thus simplifying service. The new and intelligent control system ensures that operators are alerted as soon as something is wrong, or even risks becoming a problem. This means that many faults can be eliminated before they arise.

Precisely narrowing down a problem also simplifies service and repairs, reducing downtime and putting you back in operation faster.



Dimensions

Model designation

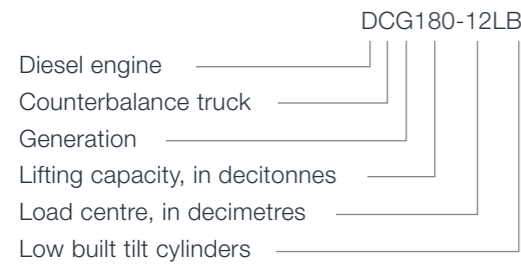

Lifting capacity in tonnes

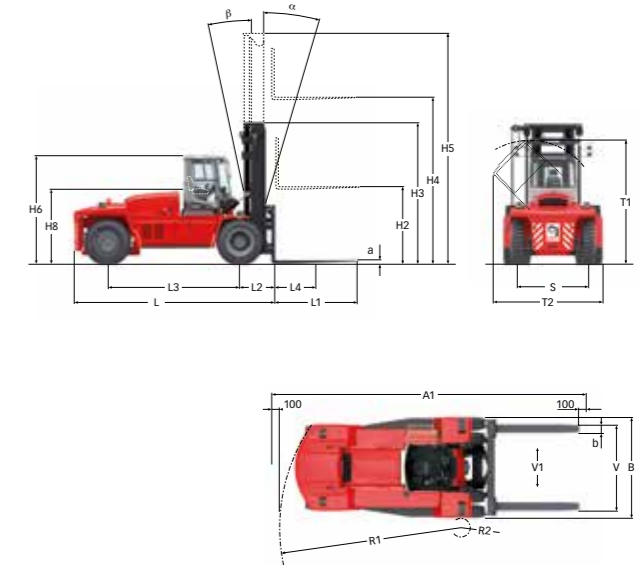
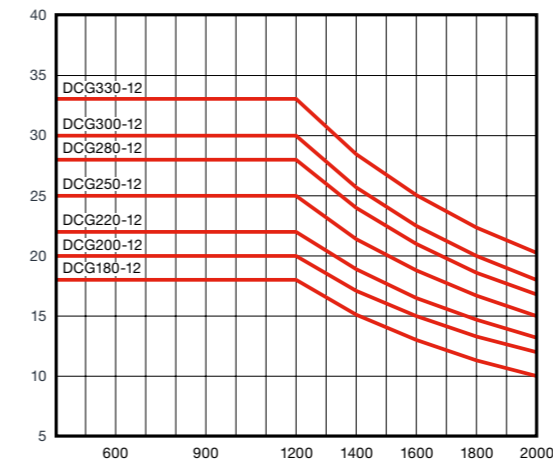

				DCG180-12LB	DCG200-12LB	DCG220-12LB	DCG250-12LB	DCG280LB	DCG300LB	DCG330LB		
Lifting	Lifting capacity	Rated	kg	18000	20000	22000	25000	28000	30000	33000		
		Load centre	L4	mm	1200	1200	1200	1200	1200	1200	1200	
Dimensions	Truck	Length, without forks	L	mm	6090	6090	6090	6340	6925	6925	6925	
		Width	B	mm	3050	3050	3050	3050	3430	3430	3430	
		Height, basic machine	H6	mm	3270	3270	3300	3270	3415	3415	3415	
		Seat height	H8	mm	2150	2150	2350	2150	2300	2300	2300	
		Distance between centre of front axle and front face of fork arm	L2	mm	1070	1070	1070	1070	1125	1125	1125	
		Wheelbase	L3	mm	4000	4000	4000	4250	4750	4750	4750	
		Track (c-c), front – rear	S	mm	2200 – 2140	2200 – 2140	2200 – 2140	2200 – 2140	2540 – 2440	2540 – 2440	2540 – 2440	
		Turning radius, outer	R1	mm	5600	5600	5600	5875	6600	6600	6600	
		Turning radius, inner	R2	mm	425	425	425	550	950	950	950	
		Ground clearance, min.		mm	300	300	300	300	300	300	300	
		Max. height when tilting cab	T1	mm	3800	3800	3800	3800	3800	3800	3800	
		Max. width when tilting cab	T2	mm	3700	3700	3700	3700	3800	3800	3800	
		Min. aisle width for 90° stacking with forks	A1	mm	9270	9270	9270	9550	10325	10325	10325	
		Standard duplex mast	Lifting height	H4	mm	5000	5000	5000	5000	5000	5000	5000
			Mast height, min.	H3	mm	4320	4320	4320	4320	4520	4520	4520
			Mast height, max.	H5	mm	6820	6820	6820	6820	7020	7020	7020
			Mast tilting, forwards – backwards	a – b	°	5 – 10	5 – 10	5 – 10	5 – 10	5 – 10	5 – 10	5 – 10
		Forks	Width	b	mm	250	250	250	250	300	300	300
			Thickness	a	mm	110	110	110	110	110	110	110
			Length of fork arm	l	mm	2400	2400	2400	2400	2400	2400	2400
Width across fork arms, max. – min.	V		mm	2600 – 1000	2600 – 1000	2600 – 1000	2600 – 1000	2750 – 1550	2750 – 1550	2750 – 1550		
Sideshift ± at width across fork arms	V1 – V		mm	400 – 1800	400 – 1800	400 – 1800	400 – 1800	300 – 2150	300 – 2150	300 – 2150		
Weight	Service weight	kg		28500	29800	31200	32900	38300	39500	41500		
		Axle load front	Unloaded	kg	15000	15000	15000	15500	20500	20500	20500	
	Axle load back	Unloaded	kg	13500	14800	16200	17400	17800	19000	21000		
		At rated load	kg	3300	3500	3700	4100	4100	4300	4800		
Wheels, brakes and steering	Wheels/tyres	Type		Pneumatic	Pneumatic	Pneumatic	Pneumatic	Pneumatic	Pneumatic	Pneumatic		
		Dimensions, front – rear	inch	14.00x24 – 14.00x24	14.00x24 – 14.00x24	14.00x24 – 14.00x24	14.00x24 – 14.00x25	16.00x25 – 16.00x25	16.00x25 – 16.00x25	16.00x25 – 16.00x25		
	Number of wheels, front – rear (*driven)		4* – 2	4* – 2	4* – 2	4* – 2	4* – 2	4* – 2	4* – 2			
	Pressure	Mpa	1.0	1.0	1.0	1.0	1.0	1.0	1.0			
	Steering system	Type – manoeuvring		Hydraulic servo - Steering wheel								
	Service brake system	Type – affected wheels		Oil cooled disc brakes (wet disc brakes) – Drive wheels								
Miscellaneous	Hydraulic fluid volume	Parking brake system	Type – affected wheels	Dry, spring activated disc brake – Drive wheels								
		Hydraulic pressure	Max.	Mpa	16,5	18	20	22	19,5	20,5	22	
		Fuel volume	l	300	300	300	375	450	450	450		

Drive train

		DCG180-250LB	DCG280-330LB	
Engine	Manufacturer – type designation	Cummins QSB6,7 (Turbo-Intercooler)	Cummins QSB6,7 (Turbo-Intercooler)	
	Fuel – type of engine	Diesel – 4-stroke	Diesel – 4-stroke	
	Rating ISO 3046 – at revs	kW/hp-rpm	168/225 – 2200	194/260 – 2200
	Peak torque ISO 3046 – at revs	Nm-rpm	949 – 1500	990 – 1500
	Number of cylinders – displacement	cm3	6 – 6702	6 – 6702
	Fuel consumption, normal driving	l/h	9 – 13	13 – 15
Gearbox	Adblue consumption, normal driving	l/h	0.3 – 0.6	0.4 – 0.7
	Manufacturer – type designation	Dana - TE17000	Dana - TE17000	
	Clutch, type	Torque converter	Torque converter	
	Gearbox, type	Hydrodynamic Powershift	Hydrodynamic Powershift	
Alternator	Numbers of gears, forward – reverse	3 – 3	3 – 3	
	Type – power	W	AC – 1960	AC-1960
Starting battery	Voltage – capacity	V-Ah	2x12 – 145	2x12 – 145
Driving axle	Manufacturer – type	Kessler D91 - Differential and hub reduction	AxleTech - Differential and hub reduction	



Performance – Cummins QSB6,7 with Dana TE17000

				DCG180-12LB	DCG200-12LB	DCG220-12LB	DCG250-12LB	DCG280-12LB	DCG300-12LB	DCG330-12LB
Lifting speed	unloaded	m/s		0.33	0.33	0.33	0.33	0.35	0.35	0.35
	at 80% of rated load	m/s		0.32	0.32	0.32	0.32	0.25	0.25	0.25
Lowering speed	unloaded	m/s		0.38	0.38	0.38	0.38	0.38	0.38	0.38
	at rated load	m/s		0.38	0.38	0.38	0.38	0.38	0.38	0.38
Travelling speed, forward – reverse	unloaded	km/h		27 – 27	27 – 27	27 – 27	27 – 27	27 – 27	27 – 27	27 – 27
	at rated load	km/h		26 – 26	26 – 26	26 – 26	26 – 26	25 – 25	25 – 25	25 – 25
Gradeability	Max.	unloaded	%	74	69	65	60	65	62	60
		at rated load	%	38	35	32	29	32	30	28
	At 2 km/h	unloaded	%	51	48	44	41	43	41	40
		at rated load	%	28	26	24	22	22	21	20
Drawbar pull	Max.	kN	173	173	173	173	214	214	214	
Noise level inside	LpAZ* EGO Cabin	dB(A)	72	72	72	72	73	73	73	
Noise level outside	LwA**	dB(A)	109	109	109	109	110	110	110	

* Noise level according to EN12053 ** Noise level according to 2000/14/EC



Lifting equipment

We offer a full range of duplex, triplex and free-lift equipment. Based on our long tradition as a supplier of heavy forklifts, our lifting equipment is robust and of the highest quality.

DCG180-250
Duplex standard, clear view

Lift height	Mast height		Free-lift
H4	Min. H3	Max. H5	H2
3500			-
4000	3820	5820	-
4500	4070	6320	-
5000	4320	6820	-
5500	4570	7320	-
6000	4820	7820	-
6500	5070	8320	-
7000	5320	8820	-

DCG280-330
Duplex standard, clear view

Lift height	Mast height		Free-lift
H4	Min. H3	Max. H5	H2
4000	4020	6020	-
4500	4270	6520	-
5000	4520	7020	-
5500	4770	7520	-
6000	5020	8020	-
6500	5270	8520	-
7000	5520	9020	-

Duplex free-lift, clear view

Lift height	Mast height		Free-lift
H4	Min. H3	Max. H5	H2
3500			
4000	3920	5920	2000
4500	4170	6420	2250
5000	4420	6920	2500
5500	4670	7420	2750

Duplex free-lift, clear view

Lift height	Mast height		Free-lift
H4	Min. H3	Max. H5	H2
4000	4020	6020	2000
4500	4270	6520	2250
5000	4520	7020	2500
5500	4770	7520	2750
6000	5020	8020	3000

Triplex free-lift, clear view

Lift height	Mast height		Free-lift
H4	Min. H3	Max. H5	H2
5150	3700	6950	1900

Triplex free-lift, clear view

Lift height	Mast height		Free-lift
H4	Min. H3	Max. H5	H2
5900	4220*	8150*	2080

* Might be slightly reduced if smallest available tyres are chosen.

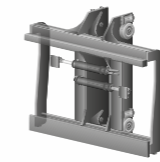

Carriage sideshift / fork positioning



Carriage with kissing forks for steel handling

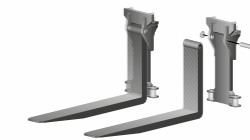

Fork shaft system (Hook on type or roller type)

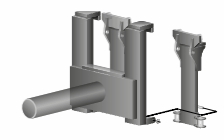

Coil ram

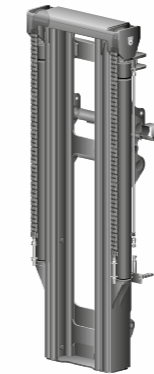

Duplex standard



Duplex free lift

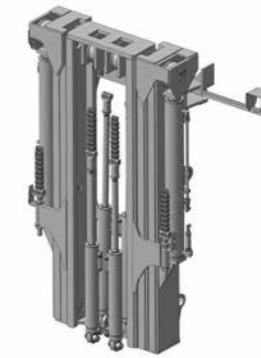

Triplex full free lift





Kalmar offers the widest range of cargo handling solutions and services to ports, terminals, distribution centres and to heavy industry. Kalmar is the industry forerunner in terminal automation and in energy efficient container handling, with one in four container movements around the globe being handled by a Kalmar solution. Through its extensive product portfolio, global service network and ability to enable a seamless integration of different terminal processes, Kalmar improves the efficiency of every move. www.kalmarglobal.com

Kalmar is part of Cargotec. Cargotec's sales totalled approximately EUR 3.2 billion in 2013 and it employs approximately 11,000 people. Cargotec's class B shares are quoted on NASDAQ OMX Helsinki under symbol CGCBV. www.cargotec.com

Cargotec Sweden AB
Torggatan 3
SE-340 10, Lidhult, Sweden
tel. +46 372 260 10
fax +46 372 263 90